

光敏电阻GL48537

Light dependent resistor GL48537

深圳市晶创和立科技有限公司的光敏电阻是一种半导体材料制成的电阻，其电导率随着光照度的变化而变化。利用这一特性制成不同形状和受光面积的光敏电阻。光敏电阻广泛应用于玩具、灯具、照相机等行业。

The Light dependent resistor of Shenzhen Jingchuang Heli Technology Co., Ltd. is a kind of resistance made of semiconductor materials, and its conductivity changes with the change of illumination. Using this characteristic, photoresists with different shapes and light receiving areas are made. Photosensitive resistors are widely used in toys, lamps, cameras and other industries.

产品示意图 (Product diagram)

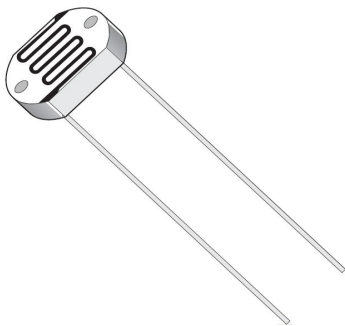

外形尺寸图 (单位 : mm)

Overall dimension drawing (unit: mm)

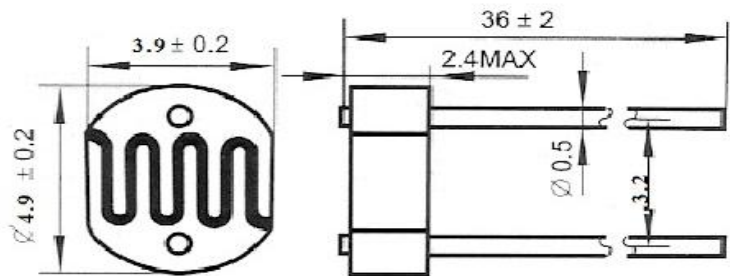

产品特点 (Product features) :

- 1, 体积小 (The product is small in size)
- 2, 环氧树脂封装 (Epoxy resin encapsulation)
- 3, 响应光谱类似人眼 (The response spectrum is similar to that of human eyes)
- 4, 应用于光线控制和光电转换 (Applied to light control and photoelectric conversion)
- 5, 高灵敏度 (High sensitivity)

GL48537的规格和电参数 (Specifications and electrical parameters of GL48537)

产品型号Model	GL48537	暗电阻Dark Resistance (MΩ)	3
最大耐压 (VDC) Vmax	150	伽马值Gamma value at 100-10Lux	0.75
最大功耗 (mW) Pmax	90	亮电阻Light Resistance at 10Lux(KΩ)	20-30
环境温度 (°C) Ambient temp	-30-+70	响应时间	上升时间Rise Time 20
光谱峰值 (nm) Spectral peak (nm)	560	Response Time (ms)	下降时间Decay time 30

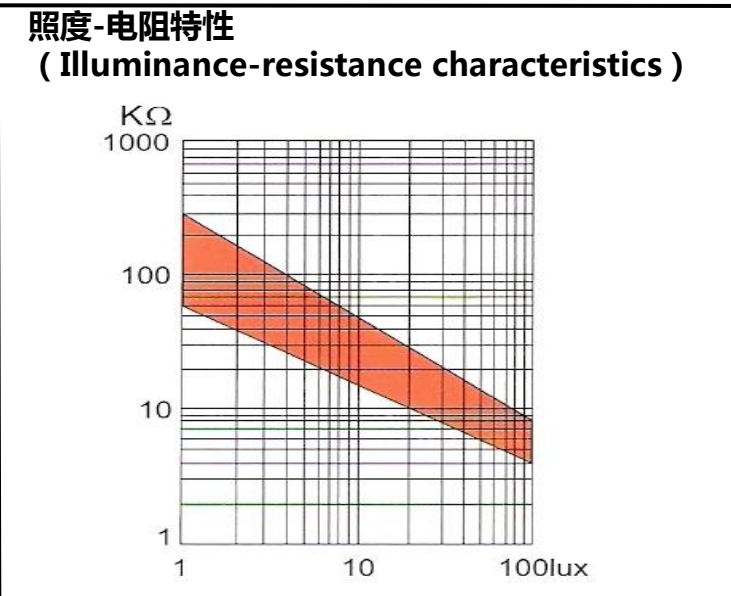
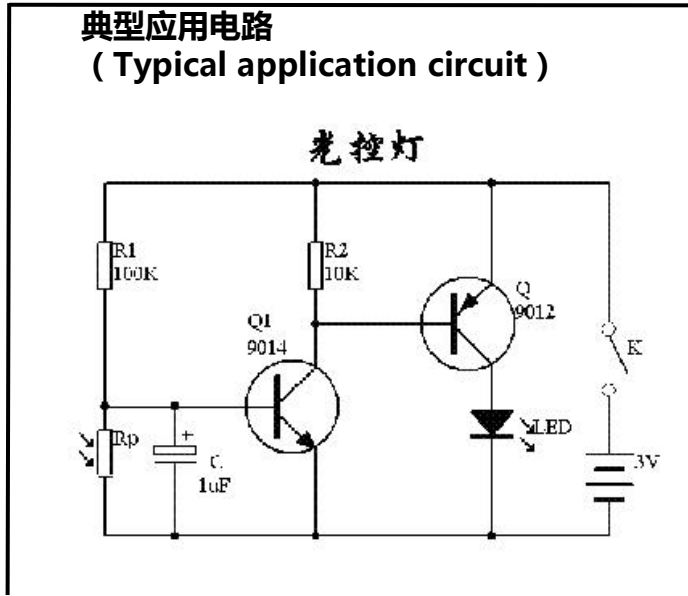
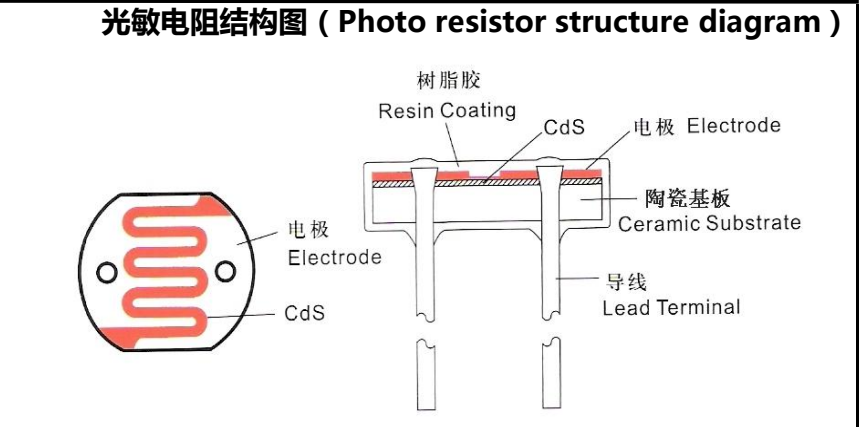
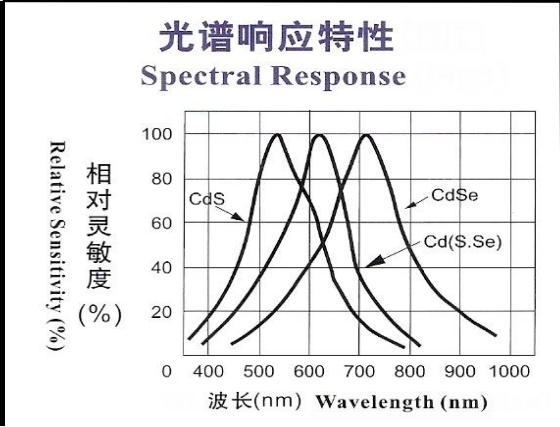

基本概念 (Basic concepts) :

- 1, 亮电阻 (Light resistance) :
在标准光源A (色温2854K)400-600LUX光线下照射2个小时后, 再在10LUX光线下测得的阻值。
Measured at 10 Lux with standard light A (2854K color temperature) and 2hr illumination at 400-600 lux prior to testing.
- 2, 暗电阻 (Dark Resistance) :
在A光源下关闭10LUX后第10秒钟的最小阻值 (Measured 10 seconds after closed 10 lux.)
- 3, 伽马值 (Gamma Characteristic) : Between 10 lux and 100 lux and given by
 $\gamma = \lg(R_{10}/R_{100})$
- 4, 最大功耗 (Wmax):环境温度为25°C时的最大功耗。
Max. power dissipation at ambient temperature of 25 °C.
- 5, 耐压 (Vmax):在黑暗状态下可连续施加到电阻上的最大电压。
Max. voltage in darkness that may be applied to the cell continuously.



包装 (packing) :

200只/袋 (200 per bag) , 1000只/盒 (1000 per box) 。 10000只/箱 (10000 per carton)

外箱标签 (Outer box label) :

	深圳市晶创和立科技有限公司
产品名称	
规格型号	
订单编号	
物料编号	
产品数量	
发货时间	

注意事项 (matters needing attention) :

- 1, 光敏电阻含有镉 (Cd) , 不符合ROHS , 如果一定要环保的光敏元件 , 选购晶创和立的光敏传感器。
The photoresist contains cadmium (Cd), which does not comply with ROHS. If you must have environmentally friendly photosensitive elements, you can choose the photosensitive sensor series of Shenzhen Jingchuang Heli Technology Co., Ltd
- 2, 储存环境 : -30-50度温度内干燥避光环境下保存 , 以免引脚氧化。
Storage environment: - 30-50 ° C, dry and protected from light to avoid pin oxidation.
- 3 , 焊接时焊点离光敏电阻本体要在3mm以上。以免高温破坏产品。
During welding, the distance between the welding spot and the photoresist body shall be more than 3mm. So as not to damage the product at high temperature.
- 4 , 焊接时不能温度过高 , 焊接时间过长。以免高温破坏产品。
During welding, the temperature shall not be too high and the welding time at shall not be too long (no more than 3 seconds). So as not to damage the product high temperature.